

UBICACIÓN

EDICIONES
TECNICAS RT

TOMAS DE DIAGNÓSTICO

SISTEMA - UBICACIÓN DE INMOVILIZADORES

La siguiente figura muestra las posibles ubicaciones de los diferentes conectores de diagnóstico, dentro del habitáculo del vehículo.

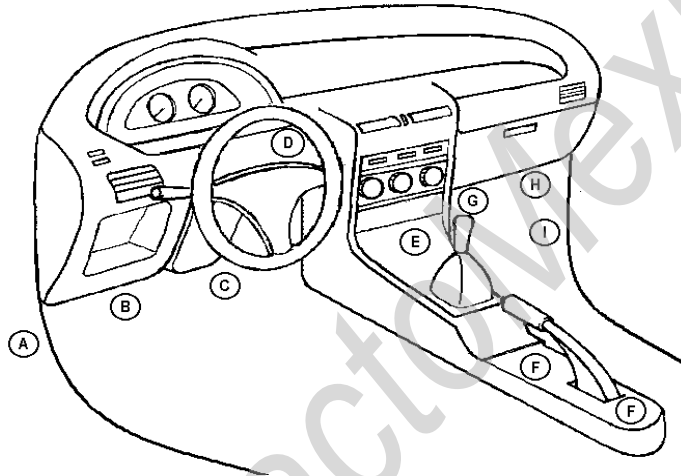

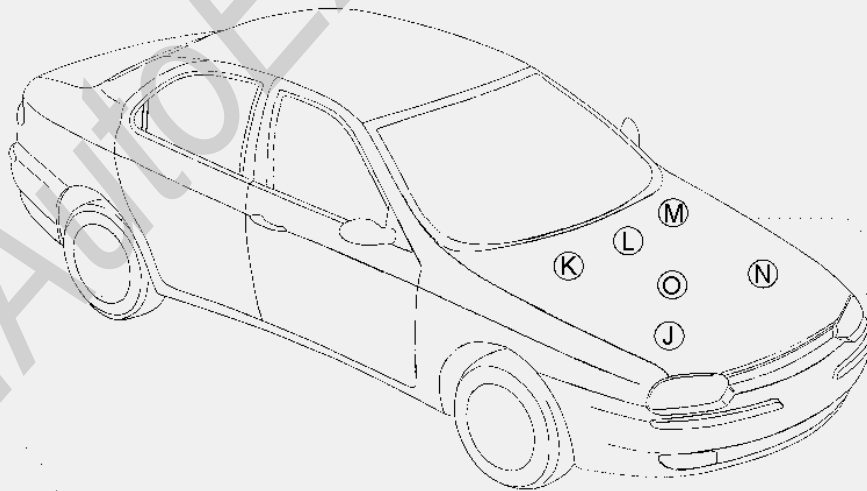

La siguiente figura muestra las posibles ubicaciones de los diferentes conectores de diagnóstico, dentro del vano del motor.





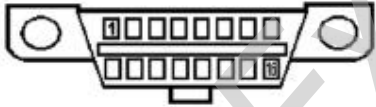
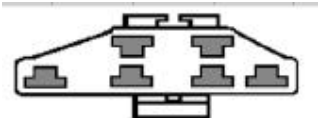

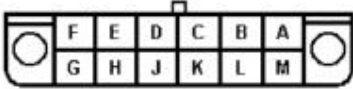



Las figuras, muestran las diferentes formas que tienen las tomas de diagnóstico, dependiendo de las marcas y modelos de los vehículos

	
OBD2	EC4
	
FIAT	ALDL-12

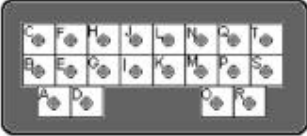
UBICACIÓN

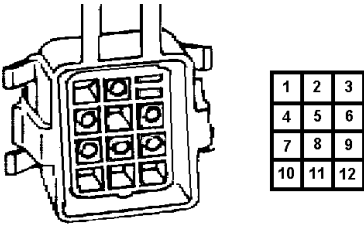
EDICIONES TÉCNICAS RT

TOMAS DE DIAGNÓSTICO

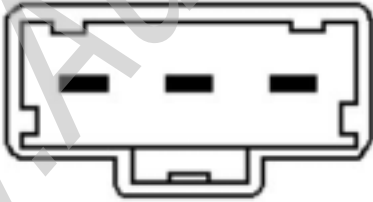
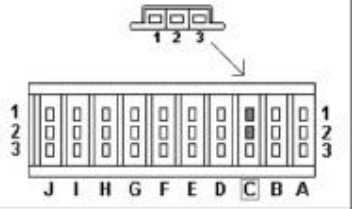
	
<p>KIA</p>	<p>ALDL-10</p>
	
<p>RENAULT – RENAULT /2</p>	<p>BMW</p>
	
<p>C1300</p>	<p>EC4 /T</p>
	
<p>HONDA</p>	<p>C-1400 LADO DEL VEHÍCULO</p>

TOMAS DE DIAGNÓSTICO



Marca	Modelo	Sistema	Año	Conector	Pos
AUDI	A3 1.6	Simos HS / AT	97 →	OBD2 / ISO	B / F
AUDI	A3 1.8	Motronic 3.8.2	97 →	OBD2 / ISO	B / F
AUDI	A3 1.8 Turbo	Motronic 3.8.2	97 →	OBD2 / ISO	B / F
AUDI	A4 1.6	Motronic 3.2	94 - 96	AUDI	M
AUDI	A4 1.6	Simos HS / AT	97 →	OBD2 / ISO	B / F
AUDI	A4 1.8	Motronic 3.8.2	97 →	OBD2 / ISO	B / F
AUDI	A4 1.8 Turbo	Motronic 3.8.2	97 →	OBD2 / ISO	B / F
AUDI	A4 2.6	Hella	96 →	AUDI -OBD2/ISO	M / B/ F
AUDI	A4 2.8	Motronic 3.8.2	97 →	OBD2 / ISO	B / F
AUDI	A6 1.8	Motronic 3.8.1	94 - 97	AUDI -OBD2/ISO	M / B/ F
AUDI	A4 2.4	Motronic 3.8.2	97 →	OBD2 / ISO	B / F
AUDI	A4 2.8	Motronic 3.8.2	97 →	OBD2 / ISO	B / F
AUDI	A8 2.8	Hitachi	94 - 96	AUDI	M
AUDI	A8 2.8	Motronic 3.8.2	97 →	OBD2 / ISO	B / F
AUDI	A8 4.2	Motronic 5.4.1	94 - 96	AUDI	M
AUDI	A80 2.0	Digifant 1.75	91 -96	AUDI	M
AUDI	A80 2.2 S2	Motronic 2.3.2	93 -96	AUDI	M
AUDI	A80 2.6	Hella	92 - 96	AUDI	M
AUDI	A80 2.8	Hitachi	91 - 96	AUDI	M
AUDI	A100 2.6	Hella	92 -94	AUDI	M
AUDI	A100 2.8	Hitachi	90 - 94	AUDI	M



Marca	Modelo	Sistema	Año	Conector	Pos
A. ROMEO	145 2.0 16 V TS	Bosch M2.10.3	93 - 96	FIAT	K

UBICACIÓN

**EDICIONES
TECNICAS RT**

TOMAS DE DIAGNÓSTICO

A. ROMEO	145 1.8 16V	Bosch M2.10.4	96 – 99	FIAT	L
A. ROMEO	145 2.0 16V	Bosch M2.10.4	96 – 99	FIAT	L
A. ROMEO	146 1.8 16V	Bosch M2.10.4	96 – 98	FIAT	L
A. ROMEO	146 2.0 16V	Bosch M2.10.4	96 – 98	FIAT	L
A. ROMEO	155 1.8 TS	Bosch M1.7	92 – 97	FIAT	L
A. ROMEO	155 2.0 TS	Bosch M1.7	92 – 97	FIAT	L
A. ROMEO	155 2.0 16 V TS BR	Bosch M2.10.3	93 – 97	FIAT	G
A. ROMEO	155 1.8 16 V	Bosch M2.10.4	95 – 99	FIAT	G
A. ROMEO	155 2.0 16 V	Bosch M2.10.4	95 – 99	FIAT	G
A. ROMEO	164 3.0 V6 12 V	Bosch M1.7	92 – 99	FIAT	G
A. ROMEO	164 3.0 V6 24 V	Bosch M1.7	93 – 97	FIAT	G
A. ROMEO	164 2.0 16 V T. Spark	Bosch M1.7	92 – 99	FIAT	G



Marca	Modelo	Sistema	Año	Conector	Pos
BMW	318	M1.7 / M42	→ 93	BMW	J
BMW	318	M1.7.2 / M42	93 – 95	BMW	J
BMW	318	M5.2 / M44	96 – 99	BMW	J
BMW	323	MS41 / M52	98 – 99	BMW	J
BMW	325	M1.1 / M20	84 – 87	BMW	J
BMW	325	M1.3 / M20	88 – 89	BMW	J
BMW	325	M3.1 / M50	90 – 92	BMW	J
BMW	325	M3.3.1/M50	93 – 95	BMW	J
BMW	328	MS41 / M52	96 – 99	BMW	J
BMW	525	M3.1 / M50	90 – 92	BMW	J
BMW	525	M3.3.1/M50	93 – 95	BMW	J
BMW	528	M1.1 / M20	86 – 88	BMW	J
BMW	528	MS41 / M52	96 – 99	BMW	J

TOMAS DE DIAGNÓSTICO

BMW	530	M3.3 / M60	94 – 95	BMW	J
BMW	535	M1.1 / M30	89 – 93	BMW	J
BMW	540	M3.3 / M60	92 – 95	BMW	J
BMW	540	M5.2 / M62	96 – 99	BMW	J
BMW	635	M1.1 / M30	85 – 87	BMW	J
BMW	635	M1.3 / M30	88 – 89	BMW	J
BMW	735	M1.1 / M30	88 – 89	BMW	J
BMW	740	M3.3 / M60	93 – 95	BMW	J
BMW	740	M5.2 / M62	96 – 99	BMW	J
BMW	750	M1.2 / M70B50	88 – 90	BMW	J
BMW	750	M1.7 / M70B50	90 – 94	BMW	J
BMW	750	M5.2.1 / M73	96 – 99	BMW	J
BMW	840	M3.3 / M60	94 – 95	BMW	J
BMW	850	M1.7 / M70B50	90 – 92	BMW	J
BMW	850	M1.7.1 / M70B56	92 – 95	BMW	J
BMW	850	M5.2.1 / M73	96 – 99	BMW	J
BMW	M3	M3.3 / S50	92 – 93	BMW	J
BMW	M3	S50 Vanos	94 – 95	BMW	J
BMW	M3	M3.3.1	94 – 95	BMW	J
BMW	M3	S50 Vanos	94 – 95	BMW	J
BMW	M3	MS41 / S52US	96 – 99	BMW	J
BMW	M5	M1.2 / S38	88 – 92	BMW	J
BMW	M5	M3.3 / S38	92 – 95	BMW	J
BMW	Z3	MS41 / M52	96 – 99	BMW	J

CHRYSLER



Marca	Modelo	Sistema	Año	Conector	Pos
CHRYSLER	Neon	OBD II - ISO	96 ->	OBD2/ISO	C
CHRYSLER	Stratus 2.0	OBD II - ISO	96 ->	OBD2/ISO	C

UBICACIÓN

**EDICIONES
TECNICAS RT**

TOMAS DE DIAGNÓSTICO

CHRYSLER	Stratus 2.4	OBD II - ISO	96 ->	OBD2/ISO	C
CHRYSLER	Stratus 2.5	OBD II - ISO	96 ->	OBD2/ISO	C
CHRYSLER	Caravan 2.0	OBD II - ISO	96 ->	OBD2/ISO	C
CHRYSLER	Caravan 2.4	OBD II - ISO	96 ->	OBD2/ISO	C
CHRYSLER	Caravan 3.3	OBD II - ISO	96 ->	OBD2/ISO	C
CHRYSLER	Caravan 3.8	OBD II - ISO	96 ->	OBD2/ISO	C
CHRYSLER	Gran Caravan	OBD II - ISO	96 ->	OBD2/ISO	C



Marca	Modelo	Sistema	Año	Conector	Pos
CITROËN	AX 1.0	Bosch MA3.0	92 - 97	C1300 + Inv.	J
CITROËN	Saxo 1.6	Bosch MP5.1	96 - 99	C1300 + Inv.	B
CITROËN	Xantia 1.6	IAW 8P.13	97 - 99	C1300	J
CITROËN	Xantia 1.8	IAW 8P.10	97 - 99	C1300	J
CITROËN	Xantia 1.8	Bosch MP5.1	93 - 97	C1300 + Inv.	J
CITROËN	Xantia 2.0	IAW 8P.20	95 - 97	C1300	J / B
CITROËN	Xantia 2.0	IAW 8P.20	95 - 97	C1400	J / B
CITROËN	Xantia 2.0 16V	Bosch MP3.2	93 - 97	C1300 + Inv.	J
CITROËN	Xsara 1.6	Bosch MP5.1	97 - 99	C1300 + Inv.	B
CITROËN	ZX 1.4	IAW 8P.12	97 - 99	C1300	N
CITROËN	ZX 1.4	Bosch MA3.0	93 - 97	C1300 + Inv.	N
CITROËN	ZX 1.6	IAW 8P.13	- > 96	C1300	J
CITROËN	ZX 1.8	Bosch MP5.1	93 - 96	C1300 + Inv.	N
CITROËN	ZX 1.8	IAW 8P.10	97 - 99	C1300	J
CITROËN	ZX 1.8	IAW 8P.10	97 - 99	C1300	J
CITROËN	ZX 2.0	IAW 8P.20	97 - 99	C1300	J
CITROËN	ZX 2.0 16V	Bosch MP3.2	97 - 99	C1400	B
CITROËN	ZX 2.0 16V	Bosch MP3.2	93 - 97	C1300	N

TOMAS DE DIAGNÓSTICO



Marca	Modelo	Sistema	Año	Conector	Pos
DAEWOO	Espero 2.0 MPI	Multec	94 – 97	ALDL-12	I
DAEWOO	Prince 2.0 MPI	Multec	93 – 95	ALDL-12	I
DAEWOO	Super Salon 2.0 MPI	Multec	93 – 95	ALDL-12	I



Marca	Modelo	Sistema	Año	Conector	Pos
DODGE	Dakota 2.5	OBD II - ISO	96 ->	OBD2/ISO	C
DODGE	Dakota 3.9	OBD II - ISO	96 ->	OBD2/ISO	C
DODGE	Ram 5.2	OBD II - ISO	96 ->	OBD2/ISO	C



Marca	Modelo	Sistema	Año	Conector	Pos
FIAT	Brava 1.6 16V	IAW - 1AF	99 - >	FIAT	L
FIAT	Brava 1.6 16V	IAW-49F	00 ->	OBD2-ISO	B
FIAT	Brava 1.8 16V	Hitachi M159	99 - >	FIAT	M
FIAT	Bravo 2.0 20V	Bosch 2.10.4	98 - >	FIAT	L
FIAT	Coupe 2.0 16V	IAW-P8A	95 – 96	FIAT	K
FIAT	Coupe 2.0 20V	Bosch 2.10.4	96 - >	FIAT	L
FIAT	Coupe Turbo	Bosch 2.10.4	96 - >	FIAT	L
FIAT	Elba 1.5 i.e	IAW-G6/G7	93 – 96	FIAT	L
FIAT	Elba 1.6 i.e	IAW-G6/G7	93 – 96	FIAT	L
FIAT	Elba 1.6 MPI	Bosch 1.5.4	95 – 96	FIAT	H

UBICACIÓN

**EDICIONES
TECNICAS RT**

TOMAS DE DIAGNÓSTICO

FIAT	Fiorino 75 i.e	Jetronic A2.2	94 – 96	FIAT	H
FIAT	Fiorino Eletronic	MICROPLEX	93 – 95	FIAT	J
FIAT	Fiorino 1.5 i.e	IAW-G6/G7	93 – 96	FIAT	L
FIAT	Fiorino 1.6 i.e	IAW-G6/G7	93 – 96	FIAT	L
FIAT	Fiorino 1.5 MPI	IAW-1G7	97 – 99	FIAT	L
FIAT	Fiorino 1.6 MPI	Bosch 1.5.4	95 – 99	FIAT + Inversor	H
FIAT	Marea 1.8 16V	Hitachi M159	99 - >	FIAT	M
FIAT	Marea W.End 1.8 16V	Hitachi M159	99 - >	FIAT	M
FIAT	Marea 2.0 20V	Bosch 2.10.4	98 - >	FIAT	J
FIAT	Marea W.End 2.0 20V	Bosch 2.10.4	98 - >	FIAT	J
FIAT	Marea 2.4 20V	Bosch ME3.1	00 ->	FIAT	M
FIAT	Marea W.End 2.4 20V	Bosch ME3.1	00 ->	FIAT	M
FIAT	Marea Turbo	Bosch 2.10.4	98 - >	FIAT	J
FIAT	Marea W.End Turbo	Bosch 2.10.4	98 - >	FIAT	J
FIAT	Siena 1.0 / 1.5 MPI	IAW-1G7	96 ->	FIAT	L
FIAT	Palio 1.0 / 1.5 MPI	IAW-1G7	96 ->	FIAT	L
FIAT	Strada 1.0 / 1.5 MPI	IAW-1G7	96 ->	FIAT	L
FIAT	Palio 1.0 8V Fire	IAW-59F	00 ->	OBD2-ISO	B
FIAT	Siena 1.0 8V Fire	IAW-59F	00 ->	OBD2-ISO	B
FIAT	Strada 1.0 8V Fire	IAW-59F	00 ->	OBD2-ISO	B
FIAT	Palio 1.0 16V Fire	Bosch ME7.3H4	00 ->	OBD2-ISO	B
FIAT	Siena 1.0 16V Fire	Bosch ME7.3H4	00 ->	OBD2-ISO	B
FIAT	Strada 1.0 16V Fire	Bosch ME7.3H4	00 ->	OBD2-ISO	B
FIAT	Palio 1.3 16V Fire	Bosch ME7.3H4	00 ->	FIAT / OBD2-ISO	O / B
FIAT	Siena 1.3 16V Fire	Bosch ME7.3H4	00 ->	FIAT / OBD2-ISO	O / B
FIAT	Palio 1.6 16V Mpi	IAW-1AB	96 – 99	FIAT	L
FIAT	Siena 1.6 16V Mpi	IAW-1AB	96 – 99	FIAT	L
FIAT	Strada 1.6 16V Mpi	IAW-1AB	96 – 99	FIAT	L
FIAT	Palio 1.6 16V Fire	IAW-49F	00 ->	OBD2-ISO	B
FIAT	Siena 1.6 16V Fire	IAW-49F	00 ->	OBD2-ISO	B

TOMAS DE DIAGNÓSTICO

FIAT	Strada 1.6 16V Fire	IAW-49F	00 ->	OBD2-ISO	B
FIAT	Palio 1.6 i.e	IAW-1G7	98 ->	FIAT	L
FIAT	Siena 1.6 i.e	IAW-1G7	98 ->	FIAT	L
FIAT	Strada 1.6 i.e	IAW-1G7	98 ->	FIAT	L
FIAT	Panda 1.0 - 1.1 i.e	Jetronic A2.2	87 - 92	FIAT	H
FIAT	Premio 1.5 i.e	IAW-G6/G7	93 - 96	FIAT	L
FIAT	Premio 1.6 i.e	IAW-G6/G7	93 - 96	FIAT	L
FIAT	Regata 75/ 90 i.e	Jetronic A2.2	87 - 90	FIAT	H
FIAT	Ritimo 75/ 90 i.e	Jetronic A2.2	87 - 90	FIAT	H
FIAT	Tempra 1.6 i.e	Jetronic A2.2	90 - 92	FIAT	H
FIAT	Tempra 2.0 8V	IAW-G6/G7	93 - 99	FIAT	H
FIAT	Tempra 2.0 16V	IAW-P8	93 - 94	FIAT	H
FIAT	Tempra 2.0 SW	IAW-P8	95 - 97	FIAT	K
FIAT	Tempra 2.0 16V	IAW-G7.25	95 - 99	FIAT	H
FIAT	Stile 2.0	Bosch 1.5.2	95 - 99	FIAT	H
FIAT	Tempra Turbo 2.0	Bosch 1.5.2	95 - 99	FIAT	H
FIAT	Tipo 1.6 i.e	Mono MA 1.7	94 - 95	FIAT	J
FIAT	Tipo 1.6 MPI	Bosch 1.5.4	96 - 97	FIAT	H
FIAT	Tipo 2.0	IAW-P8	94 - 96	FIAT	K
FIAT	Tipo 2.0 16V	IAW-P8A	95	FIAT	H
FIAT	Uno 45	Jetronic A2.2	87 - 94	FIAT	H
FIAT	Uno 70	Jetronic A2.2	87 - 94	FIAT	H
FIAT	Uno 75	Jetronic A2.2	87 - 94	FIAT	H
FIAT	Uno 1.1 i.e	Jetronic A2.2	87 - 94	FIAT	H
FIAT	Uno Mille ELX	MICROPLEX	93 - 95	FIAT	J
FIAT	Uno Eletronic	MICROPLEX	93 - 95	FIAT	J
FIAT	Uno Mille EP	IAW-G7.11	95 - 96	FIAT	L
FIAT	Uno Mille i.e	IAW-G7.11	95 - 96	FIAT	L
FIAT	Uno Mille SX	IAW-G7.11	95 - 96	FIAT	L
FIAT	Uno 1.5 i.e	IAW-G6/G7	93 - 96	FIAT	L/H

UBICACIÓN

**EDICIONES
TECNICAS RT**

TOMAS DE DIAGNÓSTICO

FIAT	Uno 1.6 MPI	Bosch 1.5.4	95 – 96	FIAT	H
					
Marca	Modelo	Sistema	Año	Conector	Pos
FORD	Courier 1.3	EEC-V	97 – 99	OBD2 / SAE	A
FORD	Courier 1.4 16V	EEC-V	97 – 99	OBD2 / SAE	A
FORD	Courier 1.6 (ROCAM)	EEC-V	99 – 01	OBD2 / SAE	A
FORD	Escort 1.6 CFI	EEC-IV	94 – 96	EC4	N
FORD	Escort 1.8 CFI	EEC-IV	94 – 96	EC4	N
FORD	Escort 1.8 16V - Zetec	EEC-IV / (DLC)	97 – 01	EC4 / DLC	I
FORD	Escort 2.0 EFI	EEC-IV	95 – 96	EC4	N
FORD	Escort 1.6 (ROCAM)	EEC-V	00 – 01	OBD2 / SAE	I
FORD	Explorer	EEC-V	96 – 01	OBD2 / SAE	C
FORD	Fiesta 1.0	EEC-V	99 – 00	OBD2 / SAE	A
FORD	Fiesta 1.0 (ROCAM)	EEC-V	99 – 01	OBD2 / SAE	A
FORD	Fiesta 1.3	EEC-IV	94 – 96	EC4 / T	O
FORD	Fiesta 1.3	EEC-V	99 – 00	OBD2 / SAE	A
FORD	Fiesta 1.4 16V	EEC-V	99 – 00	OBD2 / SAE	A
FORD	Fiesta 1.6 (ROCAM)	EEC-V	99 – 01	OBD2 / SAE	A
FORD	Focus 1.8 16V	EEC-V	01 ->	EC5 / F	B
FORD	Focus 2.0 16V	EEC-V	01 ->	EC5 / F	B
FORD	F1000 4.9	EEC-IV 3 Dig.	95 - 98	EC4	N
FORD	KA 1.0	EEC-V	97 – 99	OBD2 / SAE	A
FORD	KA 1.0 (ROCAM)	EEC-V	99 – 01	OBD2 / SAE	A
FORD	KA 1.3	EEC-V	97 – 99	OBD2 / SAE	A
FORD	Mondeo 1.6 16V	EEC-IV / (DLC)	-> 96	EC4 / DLC	C
FORD	Mondeo 1.8 16V	EEC-IV / (DLC)	-> 96	EC4 / DLC	C
FORD	Mondeo 2.0 16V	EEC-IV / (DLC)	-> 96	EC4 / DLC	C
FORD	Mondeo 2.0	EEC-V	97 – 01	OBD2 / SAE	C

TOMAS DE DIAGNÓSTICO

FORD	Ranger	EEC-IV 3 Dig.	93 – 95	EC4	N
FORD	Ranger	EEC-V	95 – 01	OBD2 / SAE	C
FORD	Royale 1.8 CFI	EEC-IV	94 – 96	EC4	I
FORD	Royale 2.0 EFI	EEC-IV	94 – 96	EC4	I
FORD	Taurus 3.0	EEC-IV	94 – 97	EC4	N
FORD	Taurus 3.0	EEC-V	97 – 01	OBD2 / SAE	C
FORD	Versailles 1.8 CFI	EEC-IV	94 – 96	EC4	N
FORD	Versailles 2.0 EFI	EEC-IV	94 – 96	EC4	N
FORD	Verona 1.8 CFI	EEC-IV	94 – 96	EC4	N
FORD	Verona 2.0 EFI	EEC-IV	94 – 96	EC4	N
FORD	Windstar 3.8	EEC-V	95 ->	OBD2 / SAE	H



Marca	Modelo	Sistema	Año	Conector	Pos
GM	Astra 2.0 MPFI	Bosch 1.5.2	95 – 98	ALDL-10	B
GM	Astra G 1.8 MPFI	Bosch M1.5.5	98 – 01	OBD2 / ISO	F
GM	Astra G 2.0 MPFI	Bosch M1.5.5	98 – 01	OBD2 / ISO	F
GM	Astra G 2.0 16V MPFI	Bosch M1.5.5	98 – 01	OBD2 / ISO	F
GM	Blazer 2.2 EFI	Multec B22	95 – 97	OBD2 / ISO	C
GM	Blazer 2.2 MPFI	Bosch 1.5.4	98 – 01	OBD2 / ISO	C
GM	Blazer 4.3 V6	Delco	97 – 01	OBD2/SAE	C
GM	Calibra 2.0 16V	Motronic 2.8	94 – 96	ALDL-10	M
GM	Celta 1.0 MPFI	Multec H	00 - 01	OBD2 / ISO	B
GM	C20 4.1	Motronic 2.8	96 – 96	ALDL-12+Adp.12	C
GM	Corsa 1.4 EFI	Multec 700	94 – 96	ALDL-10	B
GM	Corsa 1.0 EFI	Multec 700	94 – 96	ALDL-10	B
GM	Corsa 1.0 MPFI	Multec MPFI	96 – 01	ALDL-10 / OBD2	B
GM	Corsa 1.6 MPFI	Multec MPFI	96 – 01	ALDL-10 / OBD2	B

UBICACIÓN

**EDICIONES
TECNICAS RT**

TOMAS DE DIAGNÓSTICO

GM	Corsa 1.0 16V i	Multec -F	99 - 01	ALDL-10 / OBD2	B
GM	Corsa 1.6 16V Gsi	Multec -S	95 - 96	ALDL-10	B
GM	Corsa 1.6 16V	Multec -M	97 - 01	ALDL-10 / OBD2	B
GM	Corsa Pick-up 1.6 EFI	Multec EMS	95 - 96	ALDL-10	B
GM	Corsa Pick-up 1.6 MPI	Multec MPFI	96 - 99	ALDL-10	B
GM	Ipanema 1.8	Multec 700	92 - 97	ALDL-12	I
GM	Ipanema 2.0	Multec 700	92 - 97	ALDL-12	I
GM	Kadett 1.8	Multec 700	92 - 97	ALDL-12	I
GM	Kadett 2.0	Multec 700	92 - 97	ALDL-12	I
GM	Kadett 2.0 MPFI	Motronic 1.5.4	96 - 98	ALDL-12+Adp.12	C
GM	Monza 1.8	Multec 700	91 - 96	ALDL-12	I
GM	Monza 2.0	Multec 700	91 - 96	ALDL-12	I
GM	Omega 2.0 / 3.0	Motronic 1.5.1	93 - 94	ALDL-10	K
GM	Omega 2.2	Multec EMS	95 - 99	ALDL-12+Adp.12	C
GM	Omega 4.1	Motronic 2.8	95 - 99	ALDL-12+Adp.12	C
GM	S10 2.2 EFII	Multec B22	95 - 97	OBD2 / ISO	C
GM	S10 2.2 MPFI	Motronic 1.5.4	98 - 01	OBD2 / ISO	C
GM	S10 4.3 V6	Delco	97 - 01	OBD2/SAE	C
GM	Silverado 4.1	Motronic 2.8	96 - 96	ALDL-12+Adp.12	C
GM	Suprema 2.0 / 3.0	Motronic 1.5.1	93 - 94	ALDL-10	K
GM	Suprema 2.2	Multec EMS	95 - 99	ALDL-12+Adp.12	C
GM	Suprema 4.1	Motronic 2.8	95 - 99	ALDL-12+Adp.12	C
GM	Tigra 1.6 16V	Multec -F	98 - 01	ALDL-10 / OBD2	B
GM	Vectra 2.0 GLS / CD	Motronic 1.5.1	94 - 96	ALDL-10	M
GM	Vectra 2.0 16V GSI	Motronic 2.8	94 - 96	ALDL-10	M
GM	Vectra B 2.0 MPFI	Motronic 1.5.4P	96 - 98	OBD2 / ISO	F
GM	Vectra B 2.0 16V MPFI	Motronic 1.5.4P	96 - 98	OBD2 / ISO	F
GM	Vectra B 2.2 MPFI	Motronic 1.5.4	97 - 01	OBD2 / ISO	F
GM	Vectra B 2.2 16V MPFI	Motronic 1.5.4	97 - 01	OBD2 / ISO	F
GM	Zafira 2.0 MPFI	Motronic M1.5.5	00 - 01	OBD2 / ISO	F

TOMAS DE DIAGNÓSTICO

GM	Zafira 2.0 16V MPFI	Motronic M1.5.5	00 – 01	OBD2 / ISO	F
					
Marca	Modelo	Sistema	Año	Conector	Pos
HONDA	Accord 2.0	PGM-FI	93 ->	HONDA	I / E
HONDA	Civic 1.5	PGM-FI	91 ->	HONDA	I / E
HONDA	Civic 1.6	PGM-FI	94 ->	HONDA	I / E
HONDA	Civic 1.6 BR	PGM-FI	98 ->	HONDA	I / E
HONDA	Prelude 2.2	PGM-FI	93 ->	HONDA	I / E
Jeep					
Marca	Modelo	Sistema	Año	Conector	Pos
JEEP	Cherokee	OBD II - ISO	96 ->	OBD2/ISO	C
JEEP	Gran Cherokee	OBD II - ISO	96 ->	OBD2/ISO	C
JEEP	Wrangler	OBD II - ISO	96 ->	OBD2/ISO	C
					
Marca	Modelo	Sistema	Año	Conector	Pos
KIA	Carens 1.8	DOHC TED	97 ->	KIA - OBD2/ISO	M / C
KIA	Clarus 1.8 16V	Bosch 2.10.3	96 ->	KIA - OBD2/ISO	M / C
KIA	Clarus 2.0 16V	Bosch 2.10.3	96 ->	KIA - OBD2/ISO	M / C
KIA	Enterprise 2.5	J5 DOHC	97 ->	KIA - OBD2/ISO	M / C
KIA	Enterprise 3.0	J5 DOHC	97 ->	KIA - OBD2/ISO	M / C
KIA	Enterprise 3.6	J6 DOHC	97 ->	KIA - OBD2/ISO	M / C
KIA	Retona 2.0	KIA	97 ->	KIA - OBD2/ISO	M / C

UBICACIÓN

EDICIONES
TECNICAS RT

TOMAS DE DIAGNÓSTICO

KIA	Rio 1.3	KIA	00 ->	KIA - OBD2/ISO	M / C
KIA	Rio 1.5	KIA	00 ->	KIA - OBD2/ISO	M / C
KIA	Sephia II 1.5 16V	Siemens FX5.1	98 ->	KIA - OBD2/ISO	L / C
KIA	Sephia II 1.8	DOHC TED	97 ->	KIA - OBD2/ISO	M / C
KIA	Shuma 1.5 16V	Siemens FX5.1	98 ->	KIA - OBD2/ISO	L / C
KIA	Shuma 1.8 DOHC	Motronic 4.6	97 ->	KIA - OBD2/ISO	M / C
KIA	Spectra 1.5	KIA	00 ->	KIA - OBD2/ISO	M / C
KIA	Spectra 1.6	KIA	00 ->	OBD2/ISO	M / C
KIA	Spectra 1.6	KIA	00 ->	KIA	M / C
KIA	Sportage 2.0 DOHC	Motronic 2.10.1	93 - 97	KIA	M
KIA	Sportage 2.0 DOHC	HFM	97 ->	OBD2/ISO	M / C
KIA	Sportage 2.0 DOHC	HFM	97 ->	KIA	M / C



Marca	Modelo	Sistema	Año	Conector	Pos
M. BENZ	Clase A160	VDO MSM 1.1	98 - 01	OBD2 / ISO	B
M. BENZ	Clase A190	VDO MSM 1.1	00 - 01	OBD2 / ISO	B
M. BENZ	ML320	ME2	98 - 01	OBD2 / ISO	C



Marca	Modelo	Sistema	Año	Conector	Pos
MITSUBISHI	Pajero 3.5	OBDII / ISO	96 - 99	OBD2 / ISO	C
MITSUBISHI	Eclipse 2.0 T	OBDII / ISO	96 - 99	OBD2 / ISO	C

TOMAS DE DIAGNÓSTICO



Marca	Modelo	Sistema	Año	Conector	Pos
NISSAN	Pathfinder 3.0	OBDII / ISO	96 – 99	OBD2 / ISO	C
NISSAN	Pick Up 3.0	OBDII / ISO	96 – 99	OBD2 / ISO	C



Marca	Modelo	Sistema	Año	Conector	Pos
SEAT	Cordoba 1.6	Motronic1.2.3	95 – 99	OBD2 / ISO	D
SEAT	Cordoba 1.8	Motronic1.2.3	95 – 99	OBD2 / ISO	D
SEAT	Ibiza 1.6	Motronic1.2.3	95 – 99	OBD2 / ISO	D
SEAT	Ibiza 1.8	Motronic1.2.3	95 – 99	OBD2 / ISO	D



Marca	Modelo	Sistema	Año	Conector	Pos
PEUGEOT	106 1.0 KID	Bosch MA3.0	94 – 96	C1300 + Inv.	J
PEUGEOT	106 1.0 XN	Bosch MA3.0	94 – 96	C1300 + Inv.	J
PEUGEOT	106 1.4 XT	Bosch MA3.0	94 – 96	C1300 + Inv.	J
PEUGEOT	106 1.3	M.M. IAW 8P.2	94 – 98	C1300	J
PEUGEOT	205 1.0 Júnior	Bosch MA3.0	93 - 97	C1300 + Inv.	L
PEUGEOT	205 1.4 CJ	Bosch MA3.0	93 - 97	C1300 + Inv.	L
PEUGEOT	205 1.4 XSI	Bosch MA3.0	93 - 97	C1300 + Inv.	L
PEUGEOT	306 1.6 XS	Bosch MP5.1	93 – 97	C1300 + Inv.	L
PEUGEOT	306 1.6 XS	Bosch MP5.2	97 – 98	C1300	L

UBICACIÓN

**EDICIONES
TECNICAS RT**

TOMAS DE DIAGNÓSTICO

PEUGEOT	306 2.0 XSI	IAW 8P-20	94 – 98	C1300	M
PEUGEOT	306 1.8 XN	IAW 8P-10	94 – 98	C1300	M
PEUGEOT	306 1.8 XR	IAW 8P-10	94 – 98	C1300	M
PEUGEOT	306 1.8 XT	IAW 8P-10	94 – 98	C1300	M
PEUGEOT	306 1.8 SR	IAW 8P-10	94 – 98	C1300	M
PEUGEOT	306 2.0 16V S16	Bosch MP3.2	93 – 97	C1300 + Inv.	M
PEUGEOT	306 1.8 Cabrio	IAW 8P-10	94 – 98	C1300	M
PEUGEOT	306 2.0 Cabrio	IAW 8P-20	94 – 97	C1300	M
PEUGEOT	306 2.0 Cabrio	Bosch MP5.2	97 – 98	C1300	M
PEUGEOT	405 1.8 SR	Bosch MP5.1	92 – 97	C1300 + Inv.	M
PEUGEOT	405 1.8 SR	IAW 8P-10	94 – 98	C1300	N
PEUGEOT	405 1.8 GR	IAW 8P-10	94 – 98	C1300	N
PEUGEOT	405 2.0 SRI	IAW 8P-20	94 – 98	C1300	J
PEUGEOT	405 2.0 STI	IAW 8P-20	94 – 98	C1300	J
PEUGEOT	405 2.0 MI16	Bosch MP3.2	93 – 97	C1300 + Inv.	N
PEUGEOT	406 1.8 16V	Bosch MP5.1	95 ->	C1300 + Inv.	B
PEUGEOT	406 2.0 16V	Bosch MP5.1	95 ->	C1300 + Inv.	B
PEUGEOT	406 2.0 16V	Bosch MP5.2	95 - 99	C1400	B
PEUGEOT	605 2.0	Bosch MP5.1	93 - 98	C1300 + Inv.	B
PEUGEOT	605 2.0	Bosch MP5.2	93 - 98	C1300 + Inv.	B
PEUGEOT	605 2.0 16V	Bosch MP5.1	93 - 95	C1300 + Inv.	B
PEUGEOT	605 2.0 16V	Bosch MP5.1	95 ->	C1400	B
PEUGEOT	806 2.0	IAW 8P	95 – 95	C1300	B
					
Marca	Modelo	Sistema	Año	Conector	Pos
RENAULT	Clio 1.0	Sirius 32E	00 ->	OBD2/ISO	E
RENAULT	Clio 1.0	Siemens	00 ->	OBD2/ISO	E

TOMAS DE DIAGNÓSTICO

RENAULT	Clio 1.2	IAW 6R	94 -96	RENAULT	H
RENAULT	Clio 1.6	Mono. MA1.7	97 - 99	RENAULT	H
RENAULT	Clio 1.6	Siemens	00 ->	OBD2/ISO	E
RENAULT	Clio 1.6	Sirius 32B	00 ->	OBD2/ISO	E
RENAULT	Kangoo 1.0	Siemens	00 ->	OBD2/ISO	E
RENAULT	Kangoo 1.0	Sirius 32E	00 ->	OBD2/ISO	E
RENAULT	Kangoo 1.6	Siemens	00 ->	OBD2/ISO	E
RENAULT	Kangoo 1.6	Sirius 32B	00 ->	OBD2/ISO	E
RENAULT	Laguna 1.8	Siemens	96 - 98	RENAULT	L
RENAULT	Laguna 1.8	FENIX 5	96 - 98	RENAULT	L
RENAULT	Laguna 3.0 V6 12V	FENIX 5	95 - 98	RENAULT /2	O
RENAULT	Laguna 3.0 V6 12V	Siemens	95 - 98	RENAULT /2	O
RENAULT	Mégane 1.6	Siemens	96 ->	OBD2 / ISO	B
RENAULT	Mégane 1.6	FENIX 5	96 ->	OBD2 / ISO	B
RENAULT	Mégane 1.6 16V	Sirius 32D	00 ->	OBD2/ISO	B
RENAULT	Mégane 1.6 16V	Siemens	00 ->	OBD2/ISO	B
RENAULT	Mégane 2.0	Siemens	98 ->	OBD2 / ISO	B
RENAULT	Mégane 2.0	FENIX 5	98 ->	OBD2 / ISO	B
RENAULT	R19 1.6	M.M. IAW G8	94 - 96	RENAULT	H
RENAULT	R19 1.6	M.M. IAW 8R	94 - 96	RENAULT	H
RENAULT	R19 1.6	Mono MA1.7	97 - 99	RENAULT	H
RENAULT	Scénic 1.6	FENIX 5	96 ->	OBD2 / ISO	B
RENAULT	Scénic 1.6	Siemens	96 ->	OBD2 / ISO	B
RENAULT	Scénic 1.6 16V	Sirius 32D	00 ->	OBD2/ISO	B
RENAULT	Scénic 1.6 16V	Siemens	00 ->	OBD2/ISO	B
RENAULT	Scénic 2.0	FENIX 5	98 ->	OBD2 / ISO	B
RENAULT	Scénic 2.0	Siemens	98 ->	OBD2 / ISO	B
RENAULT	Twingo 1.0	Sirius 32E	00 ->	OBD2/ISO	E
RENAULT	Twingo 1.0	Siemens	00 ->	OBD2/ISO	E
RENAULT	Twingo 1.2	M.M IAW 6R	94 - 96	RENAULT	O

UBICACIÓN

**EDICIONES
TECNICAS RT**

TOMAS DE DIAGNÓSTICO

RENAULT	Twingo 1.6	Siemens	00 ->	OBD2/ISO	E
RENAULT	Twingo 1.6	Sirius 32B	00 ->	OBD2/ISO	E



Marca	Modelo	Sistema	Año	Conector	Pos
TOYOTA	Camry	OBDII / ISO	96 - 99	OBD2 / SAE	C
TOYOTA	Corola	OBDII / ISO	96 - 99	OBD2 / SAE	C
TOYOTA	Hilux	OBDII / ISO	96 - 99	OBD2 / SAE	C



Marca	Modelo	Sistema	Año	Conector	Pos
VW	Gol 1.0	EEC-IV	95 - 96	EC4	K
VW	Gol 1.6	EEC-IV	95 - 96	EC4	K
VW	Gol 1.8	EEC-IV	95 - 96	EC4	K
VW	Gol 1.0 MI	Bosch MP 9.0	97 - 01	OBD2 / ISO	B
VW	Gol 1.0 8V	IAW-4LVB	01 ->	OBD2 / ISO	B
VW	Gol 1.0 16V MI	IAW-1AVS	98 - 01	OBD2 / ISO	B
VW	Gol 1.0 16V MI	IAW-1AVI	98 - 01	OBD2 / ISO	B
VW	Gol 1.0 16V	IAW-4LVB	01 ->	OBD2 / ISO	B
VW	Gol 1.0 16V Turbo	Bosch 3.8.3	00 - 01	OBD2 / ISO	B
VW	Gol 1.6 MI	IAW-1AVB	97 - 01	OBD2 / ISO	B
VW	Gol 1.6 MI	IAW-1AVP	97 - 01	OBD2 / ISO	B
VW	Gol 1.8 MI	IAW-1AVB	97 - 01	OBD2 / ISO	B

TOMAS DE DIAGNÓSTICO

VW	Gol 1.8 MI	IAW-1AVP	97 - 01	OBD2 / ISO	B
VW	Gol GTI 2.0 16V	M.M. VG7.2	96 - 97	EC4 + Inv.	K
VW	Gol 2.0 16V MI	IAW-1ABW	97 - 01	OBD2 / ISO	B
VW	Golf 1.6	SIMOS 2.1	98 ->	OBD2 / ISO	E
VW	Golf 1.8 Mi	DIGIFANT	94 - 99	OBD2 / ISO	E
VW	Golf 2.0 Mi	DIGIFANT	94 - 99	OBD2 / ISO	E
VW	Golf GL 1.8	Motronic 1.2.3	95 - 96	OBD2 / ISO	E
VW	Golf 1.8	Motronic 3.8.2	99 ->	OBD2 / ISO	E
VW	Golf 1.8T	Motronic 3.8.2	99 ->	OBD2 / ISO	E
VW	Golf 2.0T	Motronic 3.8.2	99 ->	OBD2 / ISO	E
VW	Golf 2.0 GTi	Motronic 2.9	93 - 94	AUDI	E
VW	Golf 2.0 GTi	Bosch 2.9	93 - 94	OBD2 / ISO	E
VW	Golf 2.0 GLX	DIGIFANT	94 - 96	OBD2 / ISO	E
VW	Golf 2.8 Motor VR6	Bosch 2.9	94 - 97	OBD2 / ISO	E
VW	Kombi 1.6 EFI	Bosch MP9.0	97 - 01	OBD2 / ISO	T
VW	Logus 1.6	EEC-IV	95 - 96	EC4	N
VW	Logus 1.8 CFI	EEC-IV	95 - 96	EC4	N
VW	Logus 2.0 EFI	EEC-IV	95 - 96	EC4	N
VW	Parati 1.0 16V MI	IAW-1AVS	97 - 01	OBD2 / ISO	B
VW	Parati 1.0 16V MI	IAW-1AVI	97 - 01	OBD2 / ISO	B
VW	Parati 1.0 16V MI	IAW-1AVS	97 - 01	OBD2 / ISO	B
VW	Parati 1.0 16V MI	IAW-1AVI	97 - 01	OBD2 / ISO	B
VW	Parati 1.0 16V Turbo	Motronic 3.8.3	00 - 01	OBD2 / ISO	B
VW	Parati 1.6	EEC-IV	95 - 96	EC4	K

UBICACIÓN

**EDICIONES
TECNICAS RT**

TOMAS DE DIAGNÓSTICO

VW	Parati 1.8 CFI	EEC-IV	95 – 96	EC4	K
VW	Parati 2.0 EFI	EEC-IV	95 – 96	EC4	K
VW	Parati 1.6 MI	IAW-1AVB	97 – 01	OBD2 / ISO	B
VW	Parati 1.8 MI	IAW-1AVB	97 – 01	OBD2 / ISO	B
VW	Parati 2.0 MI	IAW-1AVB	97 – 01	OBD2 / ISO	B
VW	Parati 1.6 MI	IAW-1AVP	97 – 01	OBD2 / ISO	B
VW	Parati 1.8 MI	IAW-1AVP	97 – 01	OBD2 / ISO	B
VW	Parati 2.0 MI	IAW-1AVP	97 – 01	OBD2 / ISO	B
VW	Parati 2.0 16V MI	IAW-1ABW	97 – 01	OBD2 / ISO	B
VW	Passat 2.0	SIMOS 4S	94 – 99	OBD2 / ISO	E
VW	Variant 2.0	SIMOS 4S	94 – 99	OBD2 / ISO	E
VW	Passat 2.8 VR6	Motronic 2.9	94 – 97	AUDI	E / D
VW	Passat 2.8 VR6	Motronic 2.9	94 – 97	OBD2 / ISO	E / D
VW	Passat 1.8	Motronic 3.8.2	98 – 01	OBD2 / ISO	F
VW	Passat 1.8T	Motronic 3.8.2	98 – 01	OBD2 / ISO	F
VW	Passat 2.8	Motronic 3.8.2	98 – 01	OBD2 / ISO	F
VW	Pointer 1.8 CFI	EEC-IV	94 – 96	EC4	K
VW	Pointer 2.0 EFI	EEC-IV	94 – 96	EC4	K
VW	Polo 1.8 MI	IAW-1AVB	97 – 01	OBD2 / ISO	B
VW	Polo 1.8 MI	IAW-1AVP	97 – 01	OBD2 / ISO	B
VW	Santana 1.8 CFI	EEC-IV	94 – 96	EC4	N
VW	Santana 2.0 EFI	EEC-IV	94 – 96	EC4	N
VW	Quantum 1.8 CFI	EEC-IV	94 – 96	EC4	N
VW	Quantum 2.0 EFI	EEC-IV	94 – 96	EC4	N

TOMAS DE DIAGNÓSTICO

VW	Santana 1.8 MI	IAW-1AVB	97 - 01	OBD2 / ISO	C
VW	Santana 2.0 MI	IAW-1AVB	97 - 01	OBD2 / ISO	C
VW	Quantum 1.8 MI	IAW- 1AVP	97 - 01	OBD2 / ISO	C
VW	Quantum 2.0 MI	IAW-1AVP	97 - 01	OBD2 / ISO	C
VW	Saveiro 1.6 EFI	EEC-IV	96 - 97	EC4	K
VW	Saveiro 1.8 EFI	EEC-IV	96 - 97	EC4	K
VW	Saveiro 1.8 MI	IAW-1AVB	97 - 01	OBD2 / ISO	B
VW	Saveiro 1.6 MI	IAW-1AVB	97 - 01	OBD2 / ISO	B
VW	Saveiro 1.6 MI	IAW-1AVP	97 - 01	OBD2 / ISO	B
VW	Saveiro 1.8 MI	IAW-1AVP	97 - 01	OBD2 / ISO	B

VOLVO

Marca	Modelo	Sistema	Año	Conector	Pos
VOLVO	C70 2.3T	Motronic 4.4	98 ->	OBD2 / ISO	C
VOLVO	S40 1.6	Siem. Fenix 5.1	96 ->	OBD2 / ISO	C
VOLVO	S40 1.8	Siem. Fenix 5.1	96 ->	OBD2 / ISO	C
VOLVO	S40 2.0	Siem. Fenix 5.1	96 ->	OBD2 / ISO	C
VOLVO	S70 2.5 20V	Motronic 4.4.1	96 ->	OBD2 / ISO	C
VOLVO	V40 1.6	Siem. Fenix 5.1	96 ->	OBD2 / ISO	C
VOLVO	V40 1.8	Siem. Fenix 5.1	96 ->	OBD2 / ISO	C
VOLVO	V70 2.5 20V	Motronic 4.4.1	97 ->	OBD2 / ISO	C

UBICACIÓN

EDICIONES
TECNICAS RT

TOMAS DE DIAGNÓSTICO

DIESEL				DIESEL	
Marca	Modelo	Sistema	Año	Conector	Pos
RENAULT	Mégane	Bosch MSA15.5	96 ->	OBD2 / ISO	B
DIESEL				DIESEL	
Marca	Modelo	Sistema	Año	Conector	Pos
VW	Caddy 1.9	SAUGDIESEL	96 ->	OBD2 / ISO	B
VW	Gol 1.9	SAUGDIESEL	96 ->	OBD2 / ISO	B
VW	Polo 1.9	SAUGDIESEL	96 ->	OBD2 / ISO	B
VW	Saveiro 1.9	SAUGDIESEL	96 ->	OBD2 / ISO	B
VW	Transporter 1.9	SAUGDIESEL	96 ->	OBD2 / ISO	B